

Genie®



Operator's Manual

with Maintenance Information

First Edition
Eleventh Printing
Part No. 39527

GS™-1530

GS™-1930

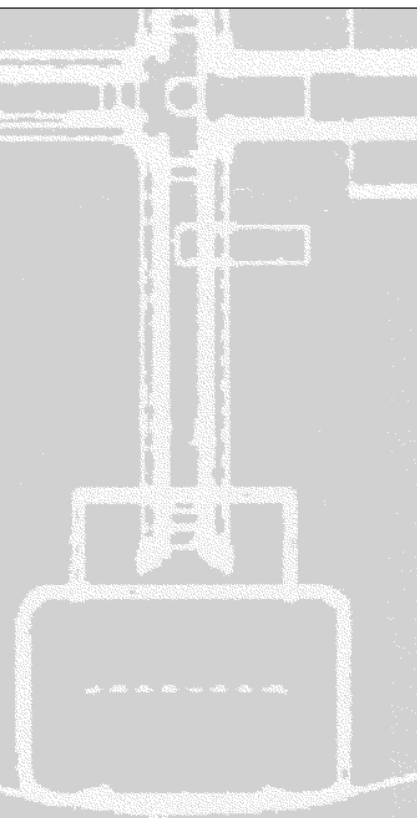

Important

Read, understand and obey these safety rules and operating instructions before operating this machine. Only trained and authorized personnel shall be permitted to operate this machine. This manual should be considered a permanent part of your machine and should remain with the machine at all times. If you have any questions, call Genie Industries.

Contents

	Page
Safety	1
Legend	8
Controls	9
Pre-operation Inspection	11
Maintenance	13
Function Tests	15
Workplace Inspection	18
Operating Instructions	20
Transport Instructions	23
Decals	24
Specifications	26

Contact us:

Internet: <http://www.genielift.com>
E-mail: techpub@genieind.com

Copyright © 1997 by Genie Industries

First Edition: Eleventh Printing, January 2002

"Genie" is a registered trademark of Genie Industries in the U.S.A. and many other countries. "GS" is a trademark of Genie Industries.

These machines comply with ANSI/SIA 92.6-1999.

 Printed on recycled paper

Printed in U.S.A.

Safety Rules



Danger

Failure to obey the instructions and safety rules in this manual will result in death or serious injury.

Do Not Operate Unless:

- You learn and practice the principles of safe machine operation contained in this operator's manual.

1 Avoid hazardous situations.

Know and understand the safety rules before going on to the next section.

2 Always perform a pre-operation inspection.

3 Always perform function tests prior to use.

4 Inspect the workplace.

5 Only use the machine as it was intended.

- You read, understand and obey:

Manufacturer's instructions and safety rules—safety and operator's manuals and machine decals

employer's safety rules and worksite regulations

applicable governmental regulations

- You** are properly trained to safely operate the machine.

SAFETY RULES

Electrocution Hazards

This machine is **not** electrically insulated and will **not** provide protection from contact with or proximity to electrical current.

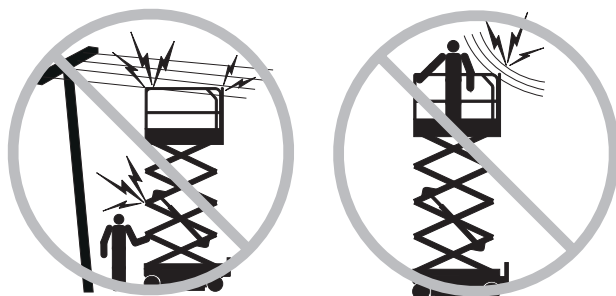

Maintain safe distances from electrical power lines and apparatus in accordance with applicable governmental regulations and the following chart.

Voltage Phase to Phase	Minimum Safe Approach Distance	
	Feet	Meters
0 to 300V	Avoid Contact	
300V to 50KV	10	3.05
50KV to 200KV	15	4.60
200KV to 350KV	20	6.10
350KV to 500KV	25	7.62
500KV to 750KV	35	10.67
750KV to 1000KV	45	13.72

Allow for platform movement, electrical line sway or sag and beware of strong or gusty winds.

Keep away from the machine if it contacts energized power lines. Personnel on the ground or in the platform must not touch or operate the machine until energized power lines are shut off.

Do not operate the machine during lightning or storms.

Do not use the machine as a ground for welding.

Tip-over Hazards

Occupants and equipment must not exceed the maximum platform capacity or the maximum capacity of the platform extension.

Maximum capacity - GS-1530		
Platform retracted	600 lbs	272 kg
Platform extended - Platform only	350 lbs	159 kg
Platform extended - Extension only	250 lbs	113 kg
Maximum occupants - ANSI and CSA	2	
Maximum occupants - CE		
Outdoor use	1	
Indoor use only	2	
Maximum occupants - Australia		
Indoor use only	2	



600 lbs / 272 kg



Extension only 250 lbs / 113 kg
Platform only 350 lbs / 159 kg

Maximum capacity - GS-1930		
Platform retracted	500 lbs	227 kg
Platform extended - Platform only	250 lbs	113 kg
Platform extended - Extension only	250 lbs	113 kg
Maximum occupants - ANSI and CSA	2	
Maximum occupants - CE		
Outdoor use	1	
Indoor use only	2	
Maximum occupants - Australia		
Indoor use only	2	



500 lbs / 227 kg



Extension only 250 lbs / 113 kg
Platform only 250 lbs / 113 kg

SAFETY RULES

Do not raise the platform unless the machine is on a firm, level surface.

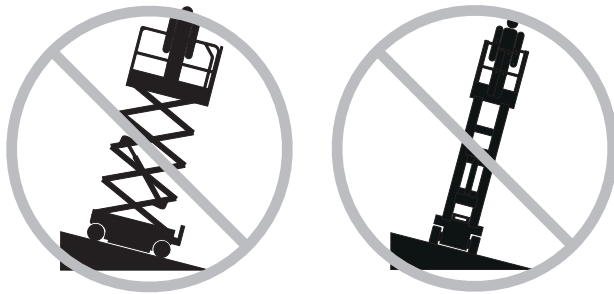

Do not depend on the tilt alarm as a level indicator. The tilt alarm sounds on the chassis only when the machine is on a slope.

If the tilt alarm sounds:
Lower the platform. Move the machine to a firm, level surface. If the tilt alarm sounds when the platform is raised, use extreme caution to lower the platform.

Do not alter or disable the limit switches.

Do not drive over 0.5 mph / 0.7 km/h with the platform raised.

Do not operate the machine in strong or gusty winds. Do not increase the surface area of the platform or the load. Increasing the area exposed to the wind will decrease machine stability.

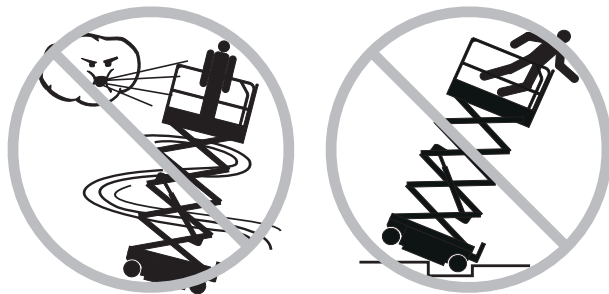

Do not drive the machine on or near uneven terrain, unstable surfaces or other hazardous conditions with the platform raised.

Use extreme care and slow speeds while driving the machine in a stowed position across uneven terrain, debris, unstable or slippery surfaces and near holes and drop-offs.

Do not use the platform controls to free a platform that is caught, snagged or otherwise prevented from normal motion by an adjacent structure. All personnel must be removed from the platform before attempting to free the platform using the ground controls.

Do not push off or pull toward any object outside of the platform.



Maximum allowable side force - ANSI & CSA
2 person 100 lbs / 445 N

Maximum allowable manual force - CE
2 person 100 lbs / 445 N
1 person 45 lbs / 200 N

Maximum allowable manual force - Australia
2 person 90 lbs / 400 N

Do not alter or disable machine components that in any way affect safety and stability.

Do not modify or alter an aerial work platform. Mounting attachments for holding tools or other materials onto the platform, toeboards or guard rail system can increase the weight in the platform and the surface area of the platform or the load.

Do not replace items critical to machine stability with items of different weight or specification.

SAFETY RULES

Do not place or attach fixed or overhanging loads to any part of this machine.



Do not place ladders or scaffolds in the platform or against any part of this machine.

Do not use the machine on a moving or mobile surface or vehicle.

Be sure all tires are in good condition, castle nuts are properly tightened and cotter pins are properly installed.

Do not use batteries that weigh less than the original equipment. Batteries are used as counterweight and are critical to machine stability. Each battery must weigh 65 pounds / 29.5 kg.

Do not use the machine as a crane.

Do not push the machine or other objects with the platform.

Do not contact adjacent structures with the platform.

Do not tie the platform to adjacent structures.

Do not place loads outside the platform perimeter.

Do not operate the machine with the chassis trays open.

Fall Hazards



Occupants should wear a safety belt or harness and comply with applicable governmental regulations. Attach the lanyard to the anchor provided in the platform.

Do not sit, stand or climb on the platform guard rails. Maintain a firm footing on the platform floor at all times.



Do not climb down from the platform when raised.

Keep the platform floor clear of debris.

Attach the platform entry chain and close the entry gate before operating.

Do not operate the machine unless the guard rails are properly installed and the entry is secured for operation.

SAFETY RULES

Collision Hazards

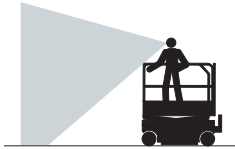

Be aware of limited sight distance and blind spots when driving or operating.

Be aware of extended platform position when moving the machine.

The machine must be on level surface or secured before releasing the brakes.

It is recommended that operators wear an approved hard hat when operating the machine.

Check the work area for overhead obstructions or other possible hazards.



Be aware of crushing hazard when grasping the platform guard rail.

Observe and use color-coded direction arrows on the platform controls and platform decal plate for drive and steer functions.

No stunt driving or horseplay while operating a machine.

Do not lower the platform unless the area below is clear of personnel and obstructions.



Limit travel speed according to the condition of the ground surface, congestion, slope, location of personnel, and any other factors which may cause collision.

Do not operate a machine in the path of any crane or moving overhead machinery unless the controls of the crane have been locked out and/or precautions have been taken to prevent any potential collision.

Crushing Hazards

Keep hands and limbs out of scissors.

Use common sense and planning when operating the machine with the controller from the ground. Maintain safe distances between the operator, the machine and fixed objects.

Component Damage Hazard

Do not use the machine as a ground for welding.

Explosion and Fire Hazard

Do not operate the machine or charge the battery in hazardous locations or locations where potentially flammable or explosive gases or particles may be present.

SAFETY RULES

Damaged Machine Hazards

Do not use a damaged or malfunctioning machine.

Conduct a thorough pre-operation inspection of the machine and test all functions before each work shift. Immediately tag and remove from service a damaged or malfunctioning machine.

Be sure all maintenance has been performed as specified in this manual and the *Genie GS-1530 & GS-1930 Service Manual*.

Be sure all decals are in place and legible.

Be sure the operator's, safety, and responsibilities manuals are complete, legible and in the storage container located on the platform.

Bodily Injury Hazard

Do not operate the machine with a hydraulic oil or air leak. An air leak or hydraulic leak can penetrate and/or burn skin.

Decal Legend

Genie product decals use symbols, color coding and signal words to identify the following:



Safety alert symbol—used to alert personnel to potential personal injury hazards. Obey all safety messages that follow this symbol to avoid possible injury or death.

▲ DANGER

Red—used to indicate the presence of an imminently hazardous situation which, if not avoided, will result in death or serious injury.

▲ WARNING

Orange—used to indicate the presence of a potentially hazardous situation which, if not avoided, could result in death or serious injury.

▲ CAUTION

Yellow with safety alert symbol—used to indicate the presence of a potentially hazardous situation which, if not avoided, may cause minor or moderate injury.

CAUTION

Yellow without safety alert symbol—used to indicate the presence of a potentially hazardous situation which, if not avoided, may result in property damage.

NOTICE

Green—used to indicate operation or maintenance information.

SAFETY RULES

Battery Safety

Burn Hazards

Batteries contain acid. Always wear protective clothing and eyewear when working with batteries.

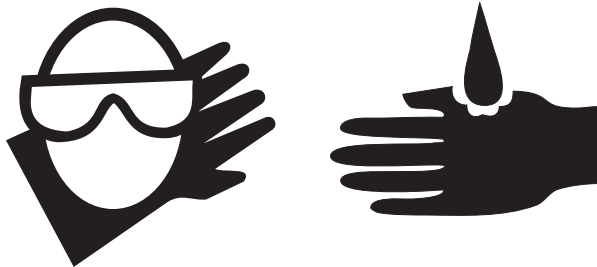

Avoid spilling or contacting battery acid. Neutralize battery acid spills with baking soda and water.

Do not expose the batteries or the charger to water and/or rain during charging.

Explosion Hazards



Keep sparks, flames and lighted tobacco away from batteries. Batteries emit an explosive gas.

The battery tray should remain open during the entire charging cycle.

Do not contact the battery terminals or the cable clamps with tools that may cause sparks.

Component Damage Hazard

Do not use any battery charger greater than 24V to charge the batteries.

Electrocution Hazards



Connect the battery charger to a grounded, AC 3-wire electrical outlet only.

Inspect daily for damaged cord, cables and wires. Replace damaged items before operating.

Avoid electrical shock from contact with battery terminals. Remove all rings, watches and other jewelry.

Tip-over Hazard

Do not use batteries that weigh less than the original equipment. Batteries are used as counterweight and are critical to machine stability. Each battery must weigh 65 pounds / 29.5 kg.

Lifting Hazard

Use the appropriate number of people and proper lifting techniques when lifting batteries.

Legend

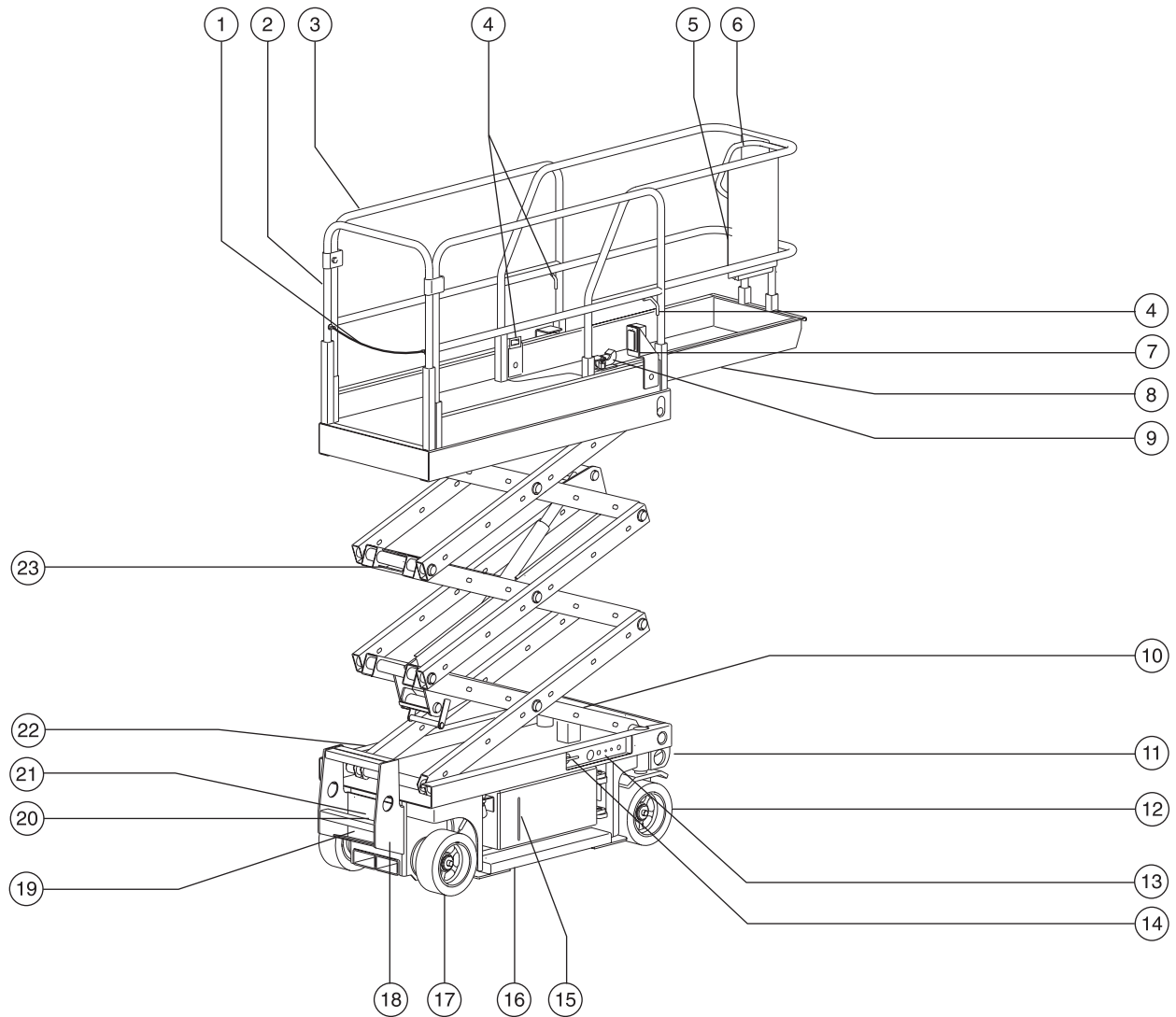

- | | | |
|------------------------------------|------------------------------------|---|
| 1 Platform entry chain or gate | 10 Tilt alarm (under cover) | 19 Battery charger |
| 2 Platform entry rail | 11 Transport tie-down | 20 Brake release pump knob |
| 3 Platform guard rails | 12 Steer tire | 21 Brake release knob |
| 4 Lanyard anchorage point | 13 Ground controls | 22 LED diagnostic readout (on opposite side of machine) |
| 5 Manual storage container | 14 Manual lowering knob | 23 Safety arm |
| 6 Platform controls | 15 Hydraulic oil level indicator | |
| 7 GFCI outlet | 16 Pothole guard | |
| 8 Platform extension | 17 Non-steer tire | |
| 9 Platform extension release pedal | 18 Entry ladder/transport tie-down | |

Controls

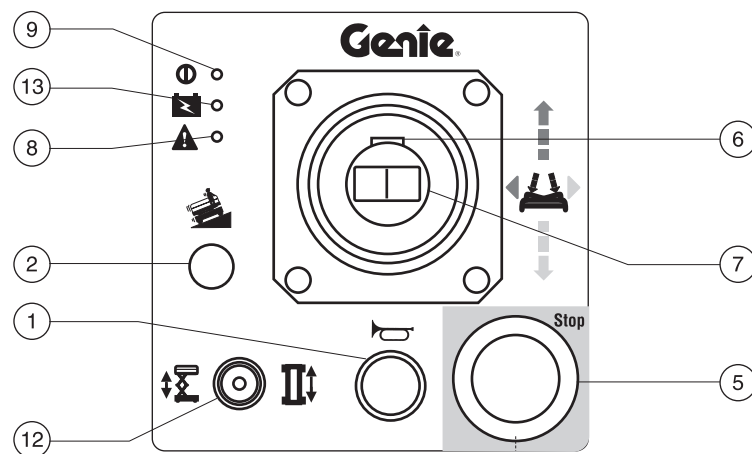
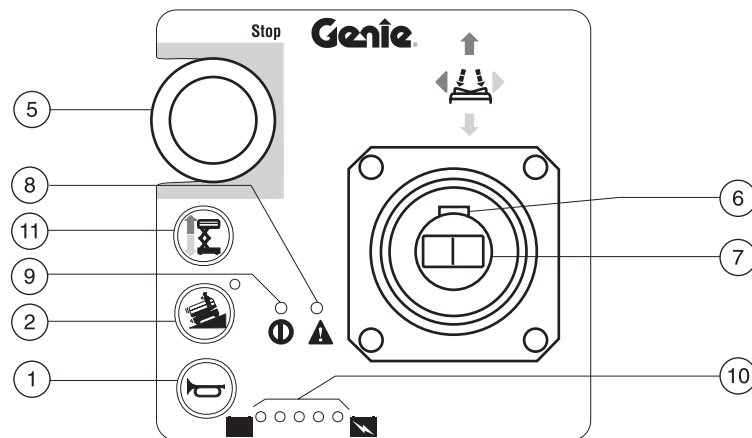
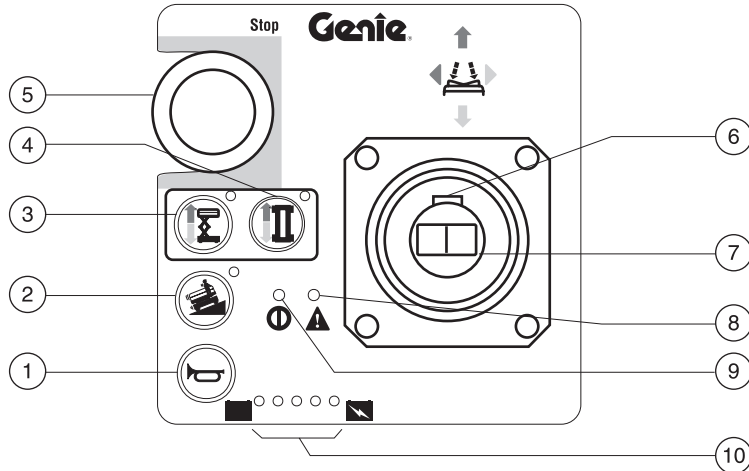

Joystick Controller

- 1 Horn
- 2 not used
- 3 Lift function select button with indicator light
- 4 Drive function select button with indicator light
- 5 Red Emergency Stop button
- 6 Function enable switch
- 7 Proportional control handle for lift and drive functions and thumb rocker for steer function
- 8 Error indicator light
- 9 Power light
- 10 Battery level indicator
- 11 Lift function enable button
- 12 Lift/drive select toggle switch
- 13 Low battery indicator light

The symbols shown below appear in the text in this operator's manual as an aid to identifying operating instructions.

Use the symbols on this page to identify which controller you have on your machine, and use the symbols in the text to identify which action to complete on your controller.

If no symbol is listed for your controller, then no action is needed.



Two function select buttons and red Emergency Stop button in upper left corner



One function select button and red Emergency Stop button in upper left corner



Red Emergency Stop button in lower right corner

CONTROLS

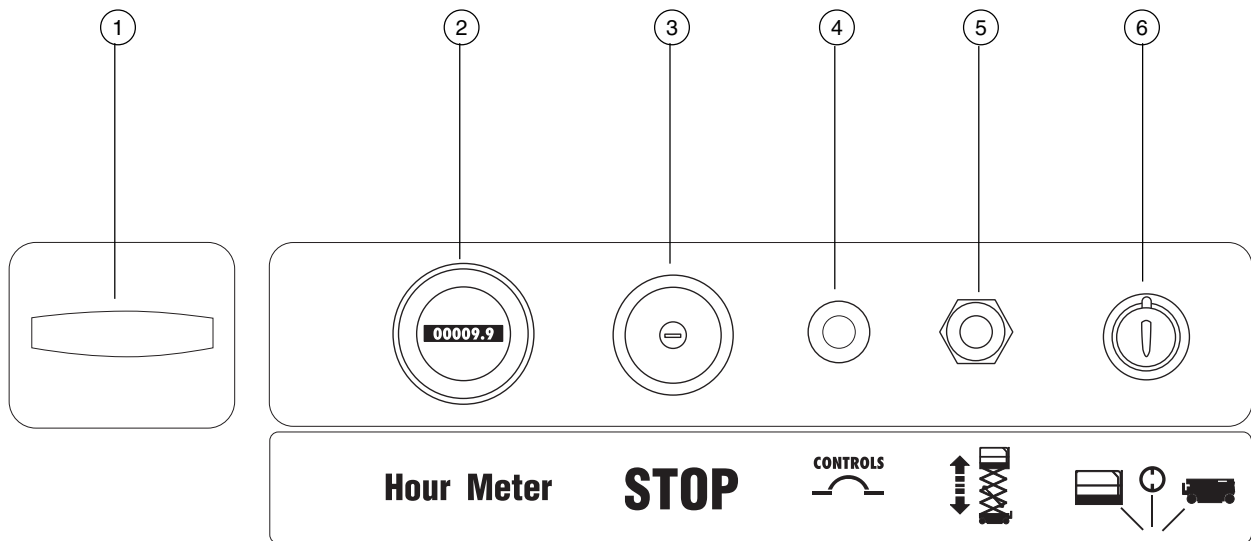

Ground Control Panel

- | | | | |
|---|---------------------------|---|--|
| 1 | Manual lowering knob | 4 | Breaker for electrical circuits |
| 2 | Hour meter | 5 | Platform up/down toggle switch |
| 3 | Red Emergency Stop button | 6 | Key switch for platform/off/ground selection |

Pre-operation Inspection



Do Not Operate Unless:

- You learn and practice the principles of safe machine operation contained in this operator's manual.
 - 1 Avoid hazardous situations.
 - 2 Always perform a pre-operation inspection.**
 - Know and understand the pre-operation inspection before going on to the next section.**
 - 3 Always perform function tests prior to use.
 - 4 Inspect the workplace.
 - 5 Only use the machine as it was intended.

Fundamentals

It is the responsibility of the operator to perform a Pre-operation Inspection and routine maintenance.

The Pre-operation Inspection is a visual inspection performed by the operator prior to each work shift. The inspection is designed to discover if anything is apparently wrong with a machine before the operator performs the function tests.

The Pre-operation Inspection also serves to determine if routine maintenance procedures are required. Only routine maintenance items specified in this manual may be performed by the operator.

Refer to the list on the next page and check each of the items and locations for modifications, damage or loose or missing parts.

A damaged or modified machine must never be used. If damage or any variation from factory delivered condition is discovered, the machine must be tagged and removed from service.

Repairs to the machine may only be made by a qualified service technician, according to the manufacturer's specifications. After repairs are completed, the operator must perform a pre-operation inspection again before going on to the function tests.

Scheduled maintenance inspections shall be performed by qualified service technicians, according to the manufacturer's specifications and the requirements listed in the responsibilities manual.

PRE-OPERATION INSPECTION

Pre-operation Inspection

- Be sure that the operator's, safety and responsibilities manuals are complete, legible and in the storage container located on the platform.
- Be sure that all decals are legible and in place. See Decals section.
- Check for hydraulic oil leaks and proper oil level. Add oil if needed. See Maintenance section.
- Check for battery fluid leaks and proper fluid level. Add distilled water if needed. See Maintenance section.

Check the following components or areas for damage, modifications and improperly installed or missing parts:

- Electrical components, wiring and electrical cables
- Hydraulic power unit, tank, hoses, fittings, cylinders and manifolds
- Battery pack and connections
- Drive motors
- Wearpads
- Tires and wheels
- Limit switches, alarms and horn
- Nuts, bolts and other fasteners
- Platform entry chain or gate
- Beacon and alarms (if equipped)
- Brake release components
- Safety arm
- Pothole guards
- Platform extension
- Scissor pins and retaining fasteners
- Platform control joystick

Check entire machine for:

- Cracks in welds or structural components
- Dents or damage to machine
- Be sure that all structural and other critical components are present and all associated fasteners and pins are in place and properly tightened.
- Be sure side rails are installed and bolts are fastened
- Be sure that the chassis trays are in place, latched and properly connected.

Maintenance



Observe and Obey:

- ☑ Only routine maintenance items specified in this manual shall be performed by the operator.
- ☑ Scheduled maintenance inspections shall be completed by qualified service technicians, according to the manufacturer's specifications and the requirements specified in the responsibilities manual.

Maintenance Symbols Legend

NOTICE

The following symbols have been used in this manual to help communicate the intent of the instructions. When one or more of the symbols appear at the beginning of a maintenance procedure, it conveys the meaning below.



Indicates that tools will be required to perform this procedure.



Indicates that new parts will be required to perform this procedure.

Check the Hydraulic Oil Level



Maintaining the hydraulic oil at the proper levels is essential to machine operation. Improper hydraulic oil levels can damage hydraulic components. Daily checks allow the inspector to identify changes in oil level that might indicate the presence of hydraulic system problems.

NOTICE

Perform this procedure with the platform in the stowed position.

- 1 Visually inspect the oil level in the hydraulic tank through the sight gauge in the side of the power unit module.
- ⦿ Result: The hydraulic oil level should be within the full and add marks on the oil level indicator decal.
- 2 Add oil if necessary. Do not overfill.

Hydraulic oil specifications

Hydraulic oil type	Dexron equivalent

MAINTENANCE

Check the Batteries



Proper battery condition is essential to good engine performance and operational safety. Improper fluid levels or damaged cables and connections can result in engine component damage and hazardous conditions.

NOTICE This procedure does not need to be performed on machines with sealed or maintenance-free batteries.

⚠ WARNING Electrocuting hazard. Contact with hot or live circuits may result in death or serious injury. Remove all rings, watches and other jewelry.

⚠ WARNING Bodily injury hazard. Batteries contain acid. Avoid spilling or contacting battery acid. Neutralize battery acid spills with baking soda and water.

NOTICE Perform this test after fully charging the batteries.

- 1 Put on protective clothing and eye wear.
- 2 Be sure that the battery cable connections are free of corrosion.
- 3 Be sure that the battery hold downs and cable connections are tight.
- 4 Remove the battery vent caps.
- 5 Check the battery acid level of each battery. If needed, replenish with distilled water to the bottom of the battery fill tube. Do not overfill.
- 6 Install the vent caps.

Scheduled Maintenance

Maintenance performed quarterly, annually and every two years must be completed by a person trained and qualified to perform maintenance on this machine according to the procedures found in the service manual for this machine.

Machines that have been out of service for more than three months must receive the quarterly inspection before they are put back into service.

Function Tests



Do Not Operate Unless:

- ☑ You learn and practice the principles of safe machine operation contained in this operator's manual.

1 Avoid hazardous situations.

2 Always perform a pre-operation inspection.

3 Always perform function tests prior to use.

Know and understand the function tests before going on to the next section.

4 Inspect the workplace.

5 Only use the machine as it was intended.

The symbols shown below appear in the text in this operator's manual as an aid to identifying operating instructions.

Use the symbols on this page and page 9 to identify which controller you have on your machine, and use the symbols in the text to identify which action to complete on your controller.

If no symbol is listed for your controller, then no action is needed.



Two function select buttons and red Emergency Stop button in upper left corner



One function select button and red Emergency Stop button in upper left corner



Controller with red Emergency Stop button in lower right corner

Fundamentals

The Function Tests are designed to discover any malfunctions before the machine is put into service. The operator must follow the step-by-step instructions to test all machine functions.

A malfunctioning machine must never be used. If malfunctions are discovered, the machine must be tagged and removed from service. Repairs to the machine may only be made by a qualified service technician, according to the manufacturer's specifications.

After repairs are completed, the operator must perform a pre-operation inspection and function tests again before putting the machine into service.

- 1 Select a test area that is firm, level and free of obstruction.
- 2 Be sure the battery pack is connected.

At the Ground Controls

- 3 Pull out the platform and ground red Emergency Stop buttons to the ON position.
- 4 Turn the key switch to ground control.
- 5 Observe the diagnostic LED readout.
- ⊙ Result: LED should read -- or 23.

Test Emergency Stop

- 6 Push in the ground red Emergency Stop button to the OFF position.
- ⊙ Result: No functions should operate.
- 7 Pull out the red Emergency Stop button to the ON position.

FUNCTION TESTS

Test the Up/Down Functions

The audible warnings on this machine and the standard horn all come from the same central alarm. The horn is a constant tone. The descent alarm sounds at 60 beeps per minute. The alarm that goes off when the pothole guards have not deployed sounds at 300 beeps per minute. The alarm that goes off when the machine is not level sounds at 600 beeps per minute. An optional automotive-style horn is also available.

8 Activate the up function.

⦿ Result: The platform should raise.

9 Activate the down function.

⦿ Result: The platform should lower. The descent alarm should sound while the platform is lowering.

Test the Manual Lowering

10 Activate the up function and raise the platform approximately 2 feet / 60 cm.

11 Pull the manual lowering knob located next to the ground controls.

⦿ Result: The platform should lower. The descent alarm will not sound.

12 Turn the key switch to platform control.

At the Platform Controls**Test Emergency Stop**

13 Push in the platform red Emergency Stop button to the OFF position.

⦿ Result: No functions should operate.

Test the Horn

14 Pull the red Emergency Stop button out to the ON position.

15 Push the horn button.

⦿ Result: The horn should sound.

Test the Function Enable Switch

16 Do not hold the function enable switch on the control handle.

17 Slowly move the control handle in the direction indicated by the blue arrow, then in the direction indicated by the yellow arrow.

⦿ Result: No functions should operate.

Test the Up/Down Functions

18  Press the lift function select button.

 Press and hold the lift function enable button.

 Move the lift/drive selector switch to the lift position (if equipped).

19 Press and hold the function enable switch on the control handle.

20 Slowly move the control handle in the direction indicated by the blue arrow.

⦿ Result: The platform should raise. The pothole guards should deploy.

21 Release the control handle.

⦿ Result: The platform should stop raising.

22 Press and hold the function enable switch. Slowly move the control handle in the direction indicated by the yellow arrow.

FUNCTION TESTS

- ⦿ Result: The platform should lower. The descent alarm should sound while the platform is lowering.

CE models: When lowering the platform, the platform should stop when it is 7 feet / 2.1 m from the ground. Be sure the area below the platform is clear of personnel and obstructions before continuing. To continue lowering, release the control handle, wait 5 seconds, then move the control handle again.

Test the Steering

Note: When performing the steer and drive function tests, stand in the platform facing the steer end of the machine.

- 23  Press the drive function select switch.

 Move the lift/drive selector switch to the drive position (if equipped).



- 24 Press and hold the function enable switch on the control handle.
- 25 Depress the thumb rocker switch on top of the control handle in the direction identified by the blue triangle on the control panel.
- ⦿ Result: The steer wheels should turn in the direction that the blue triangle points on the control panel.
- 26 Depress the thumb rocker switch in the direction identified by the yellow triangle on the control panel.
- ⦿ Result: The steer wheels should turn in the direction that the yellow triangle points on the control panel.

Test Drive and Braking



- 27 Press and hold the function enable switch.
- 28 Slowly move the control handle in the direction indicated by the blue arrow on the control panel until the machine begins to move, then return the handle to the center position.
- ⦿ Result: The machine should move in the direction that the blue arrow points on the control panel, then come to an abrupt stop.
- 29 Slowly move the control handle in the direction indicated by the yellow arrow on the control panel until the machine begins to move, then return the handle to the center position.
- ⦿ Result: The machine should move in the direction that the yellow arrow points on the control panel, then come to an abrupt stop.

Note: The drive brakes must be able to hold the machine on any slope it is able to climb.

Test Limited Drive Speed

- 30  Press the lift function select button.
-  Press and hold the lift function enable button.
-  Move the lift/drive selector switch to the lift position (if equipped).
- 31 Press and hold the function enable switch. Raise the platform approximately 4 feet / 1.2 m from the ground.
- ⦿ Result: The pothole guards should deploy.

FUNCTION TESTS

- 32  Press the drive function select switch.
-  Move the lift/drive selector switch to the drive position (if equipped).

- 33 Press and hold the function enable switch. Slowly move the control handle to the full drive position.

- ⦿ Result: The maximum achievable drive speed with the platform raised should not exceed 0.7 feet per second / 20 cm/s.

If the drive speed with the platform raised exceeds 0.7 feet per second / 20 cm/s, immediately tag and remove the machine from service.

Test the Tilt Sensor Operation

Note: Perform this test from the ground with the platform controller. Do not stand in the platform.

- 34 Fully lower the platform.
- 35 Place a 2x4 or similar piece of wood under both wheels on one side and drive the machine up onto them.
- 36 Raise the platform approximately 7 feet / 2.1 m from the ground.

Machines produced before 01-01-02:

- ⦿ Result: The tilt alarm will sound at 600 beeps per minute.
- CE and Australia models: The drive function and the lift function will not operate.
- Proceed to step 38.

Machines produced after 12-31-01:

- ⦿ Result: The platform should stop and the tilt alarm will sound at 600 beeps per minute.
- 37 Move the drive control handle in the direction indicated by the blue arrow, then move the drive control handle in the direction indicated by the yellow arrow.
- ⦿ Result: The drive function should not work in either direction.
- 38 Lower the platform and remove both pieces of wood.

Test the Pothole Guards

Note: The pothole guards should automatically deploy when the platform is raised. The pothole guards activate another limit switch which allows the machine to continue to function. If the pothole guards do not deploy, an alarm sounds and the machine will not drive.

- 39 Raise the platform.
- ⦿ Result: When the platform is raised 4 feet / 1.2 m from the ground, the pothole guards should deploy.
- 40 Press on the pothole guards on one side, and then the other.
- ⦿ Result: The pothole guards should not move.
- 41 Lower the platform.
- ⦿ Result: The pothole guards should return to the stowed position.
- 42 Place a 2x4 or similar piece of wood under a pothole guard. Raise the platform.
- ⦿ Result: Before the platform is raised 7 feet / 2.1 m from the ground, an alarm should sound and the drive function should not work.
- 43 Lower the platform and remove the 2x4.

Workplace Inspection



Do Not Operate Unless:

- You learn and practice the principles of safe machine operation contained in this operator's manual.
 - 1 Avoid hazardous situations.
 - 2 Always perform a pre-operation inspection.
 - 3 Always perform function tests prior to use.
 - 4 Inspect the workplace.**

Know and understand the workplace inspection before going on to the next section.
 - 5 Only use the machine as it was intended.

Workplace Inspection

Be aware of and avoid the following hazardous situations:

- drop-offs or holes
- bumps, floor obstructions or debris
- overhead obstructions and high voltage conductors
- hazardous locations
- inadequate surface support to withstand all load forces imposed by the machine
- wind and weather conditions
- the presence of unauthorized personnel
- other possible unsafe conditions

Fundamentals

The Workplace Inspection helps the operator determine if the workplace is suitable for safe machine operation. It should be performed by the operator prior to moving the machine to the workplace.

It is the operator's responsibility to read and remember the workplace hazards, then watch for and avoid them while moving, setting up and operating the machine.

Operating Instructions



Do Not Operate Unless:

- You learn and practice the principles of safe machine operation contained in this operator's manual.
 - 1 Avoid hazardous situations.
 - 2 Always perform a pre-operation inspection.
 - 3 Always perform function tests prior to use.
 - 4 Inspect the workplace.
- 5 Only use the machine as it was intended.**

Fundamentals

The Operating Instructions section provides instructions for each aspect of machine operation. It is the operator's responsibility to follow all the safety rules and instructions in the operator's, safety and responsibilities manuals.

Using the machine for anything other than lifting personnel and tools to an aerial work site is unsafe and dangerous.

Only trained and authorized personnel should be permitted to operate a machine. If more than one operator is expected to use a machine at different times in the same work shift, they must all be qualified operators and are all expected to follow all safety rules and instructions in the operator's, safety and responsibilities manuals. That means every new operator should perform a pre-operation inspection, function tests, and a workplace inspection before using the machine.

Emergency Stop

Push in the red Emergency Stop button to the OFF position at the ground controls or the platform controls to stop all functions.

Repair any function that operates when either Emergency Stop button is pushed in.

Operation From Ground

- 1 Turn the key switch to ground control.
- 2 Pull out both ground and platform red Emergency Stop buttons to the ON position.
- 3 Be sure the battery pack is connected before operating the machine.

To Position Platform



- 1 Move the up/down toggle switch according to the markings on the control panel.

Drive and steer functions are not available from the ground controls.

Operation From Platform

- 1 Turn the key switch to platform control.
- 2 Pull out the ground and platform red Emergency Stop buttons to the ON position.
- 3 Be sure the battery pack is connected before operating the machine.



To Position Platform

- 1  Press the lift function select button.
- 2  Press and hold the lift function enable button.
- 3  Move the lift/drive selector switch to the lift position (if equipped).
- 2 Press and hold the function enable switch on the control handle.
- 3 Move the control handle according to the markings on the control panel.



OPERATING INSTRUCTIONS

CE models: When lowering the platform, the platform should stop when it is 7 feet / 2.1 m from the ground. Be sure the area below the platform is clear of personnel and obstructions before continuing. To continue lowering, release the control handle, wait 5 seconds, then move the control handle again.

To Steer

- 1  Press the drive function select button.
 Move the lift/drive selector switch to the drive position.
- 2 Press and hold the function enable switch on the control handle.
- 3 Turn the steer wheels with the thumb rocker switch located on the top of the control handle.

To Drive

- 1  Press the drive function select button.
 Move the lift/drive selector switch to the drive position (if equipped).
- 2 Press and hold the function enable switch on the control handle.
- 3 Increase speed: Slowly move the control handle off center.
Decrease speed: Slowly move the control handle toward center.
Stop: Return the control handle to center or release the function enable switch.

Use the color-coded direction arrows on the platform controls and on the platform to identify the direction the machine will travel.

Machine travel speed is restricted when the platform is raised.

Battery condition will affect machine performance. Machine drive speed and function speed will drop when the low battery indicator light is on or when the last light on the battery level indicator is flashing.

Error Indicator Light On

If the error indicator light is on, push in and pull out the red Emergency Stop button to reset the system.

If the light stays on, tag and remove machine from service.

To Extend and Retract Platform

- 1 Step on the platform extension release pedal on the platform toeboard.
- 2 Grasp the platform guard rails carefully and push to extend the platform to the mid-position stop.
- 3 Step on the release pedal again and push to fully extend the platform.

Do not stand on the platform extension while trying to extend it.

- 4 Step on the platform extension release pedal and pull to retract the platform to the mid-position stop. Step again to fully retract the platform.

Operation From Ground with Controller

Maintain safe distances between the operator, machine and fixed objects.

Be aware of the direction the machine will travel when using the controller.

After Each Use

- 1 Select a safe parking location—firm level surface, clear of obstruction and traffic.
- 2 Lower the platform.
- 3 Turn the key switch to the off position and remove the key to secure from unauthorized use.
- 4 Chock the wheels.
- 5 Charge the batteries.

OPERATING INSTRUCTIONS

**Battery and Charger Instructions****Observe and Obey:**

- Do not use an external charger or booster battery.
- Charge the battery in a well-ventilated area.
- Use proper AC input voltage for charging as indicated on the charger.
- Use only Genie authorized battery and charger.

To Charge Battery

- 1 Be sure the batteries are connected before charging the batteries.
- 2 Open the battery compartment. The compartment should remain open for the entire charging cycle.
- 3 Remove the battery vent caps and check the battery acid level. If necessary, add only enough distilled water to cover the plates. Do not overfill prior to the charge cycle.
- 4 Replace the battery vent caps.
- 5 Connect the battery charger to a grounded AC circuit.
- 6 Turn the battery charger on.
- 7 The charger will indicate when the battery is fully charged.
- 8 Check the battery acid level when the charging cycle is complete. Replenish with distilled water to the bottom of the fill tube. Do not overfill.

Dry Battery Filling and Charging Instructions

- 1 Remove the battery vent caps and permanently remove the plastic seal from the battery vent openings.
- 2 Fill each cell with battery acid (electrolyte) until the level is sufficient to cover the plates.

Do not fill to maximum level until the battery charge cycle is complete. Overfilling can cause the battery acid to overflow during charging. Neutralize battery acid spills with baking soda and water.

- 3 Install the battery vent caps.
- 4 Charge the battery.
- 5 Check the battery acid level when the charging cycle is complete. Replenish with distilled water to the bottom of the fill tube. Do not overfill.

Transport Instructions



Observe and Obey:

- Common sense and planning must be applied to control the movement of the machine when lifting it with a crane or forklift.
- The transport vehicle must be parked on a level surface.
- The transport vehicle must be secured to prevent rolling while the machine is being loaded.
- Be sure vehicle capacity, loading surfaces and chains or straps are sufficient to withstand the machine weight. See Specifications section.
- The machine must be on a level surface or secured before releasing the brakes.

Securing to Truck or Trailer for Transit

Always chock the machine wheels in preparation for transport.

Use the tie-down points on the chassis for anchoring down to the transport surface.

Use chains or straps of ample load capacity.

Turn the key switch to the OFF position and remove the key before transporting.

Inspect the entire machine for loose or unsecured items.

Brake Release Operation

- 1 Chock wheels to prevent machine from rolling.
- 2 Be sure winch line is properly secured to drive chassis tie points and path is clear of all obstructions.
- 3 Turn the brake release knob counterclockwise to open the brake valve.
- 4 Pump the brake release pump knob.

After machine is loaded:

- 1 Chock wheels to prevent machine from rolling.
- 2 Turn the brake release knob clockwise to reset the brakes.

Towing the Genie GS-1530 or the GS-1930 is not recommended. If the machine must be towed, do not exceed 2 mph / 3.2 km/h.

Decals

Decal Inspection

Use the pictures on the next page to verify that all decals are legible and in place.

Below is a numerical list with quantities and descriptions.

Part No.	Description	Quantity
28161	Warning - Crush Hand	2
28164	Notice - Hazardous Materials	1
28171	Label - No Smoking	1
28174	Power to Platform, 230V	2
28175	Caution - Compartment Access	1
28176	Notice - Missing Manuals	1
28235	Power to Platform, 115V	2
28236	Warning - Failure To Read . . .	1
31060	Danger - Do Not Alter Limit Switch	2
31508	Notice - Power to Battery Charger	1
31785	Notice - Battery Charger Operating Instructions	1
37145	Label - Manual Lowering	1
40434	Label - Lanyard Anchorage	3
43089	Notice - Operating Instructions - Ground	1
43090	Notice - Operating Instructions - Platform	1
43091	Danger - General Safety Rules	1
43092	Notice - Max Cap 600 lbs, GS-1530, ANSI & CSA	1
43093	Notice - Tire specification	4
43094	Ground Control Panel	1
43616	Battery Connection Diagram	1
43617	Danger - Tip-over (batteries)	1
43618	Label - Directional arrows	2
43619	Label - Safety Arm	1
43658	Label - Power to Charger, 230V	1
43696	Danger - Electrocution Hazard	2

Part No.	Description	Quantity
44220	Danger/Notice - Brake Release Safety & Operating Instructions	1
44253	Notice - Side Force 100 lbs/445N, ANSI & CSA	1
44254	Notice - Max Cap 500 lbs, GS-1930, ANSI & CSA	1
44255	Danger - Crushing Hazard	4
44736	Danger - Tilt Alarm	1
44737	Danger - Tip-over, Trays Open	2
44753	Label - LED Diagnostic Readout	1
44980	Label - Power to Charger, 115V	1
44994	Label - Hydraulic Fluid Level / Dexron	1
46238	Notice - Error Indicator Light	1
46262	Danger - Battery/Charger Safety	1
52060	Notice - Side Force, Wind Speed, CE	1
52061	Notice - Max Cap 500 lbs, GS-1930, CE	1
52062	Notice - Max Cap 600 lbs, GS-1530, CE	1
52458	Serial Plate, CE	1
52475	Label, Transport Tie-down	5
52523	Serial Plate, ANSI & CSA	1
52864	Platform Control Panel	1
62053	Genie GS-1530	2
62054	Genie GS-1930	2
65052	Label - ECM Fault Codes	1
78025	Notice, Side Force, Australia	1
72833	Label, Open Latch	2
72853	Danger, Improper Use Hazard	1
82217	Notice - Manual Force, AU, 90 lbs/400N	1

DECALS

52060
or 44253
or 78025
or 82217

62053
or 62054

40434

43618

40434

28174 or
28235

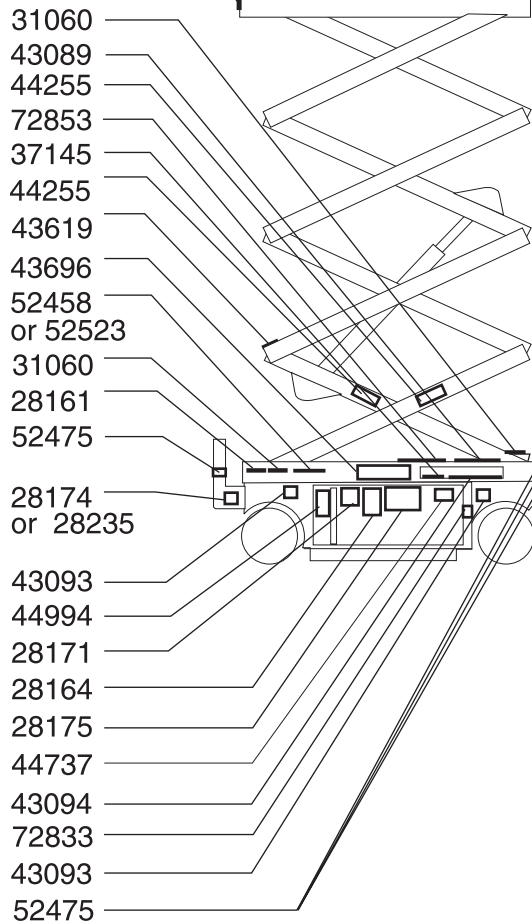
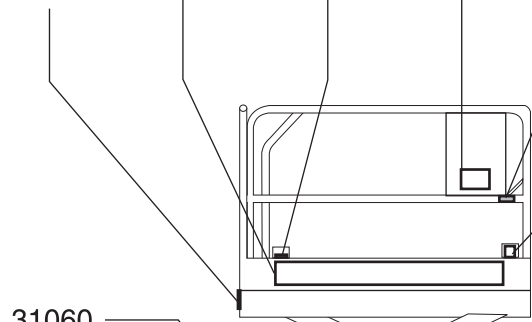

Ground Controls Side

Some decals are hidden from view when platform is lowered

Battery Side

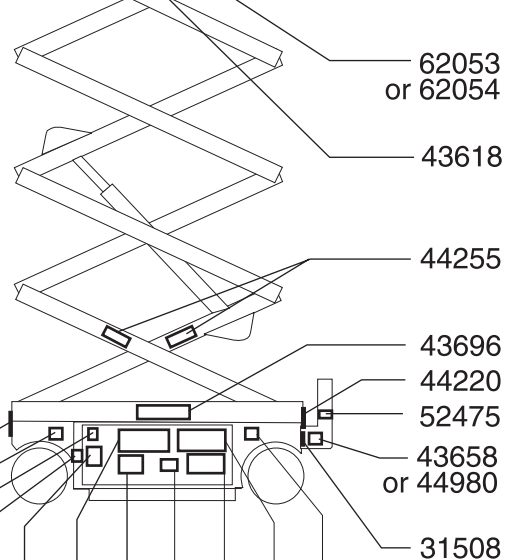
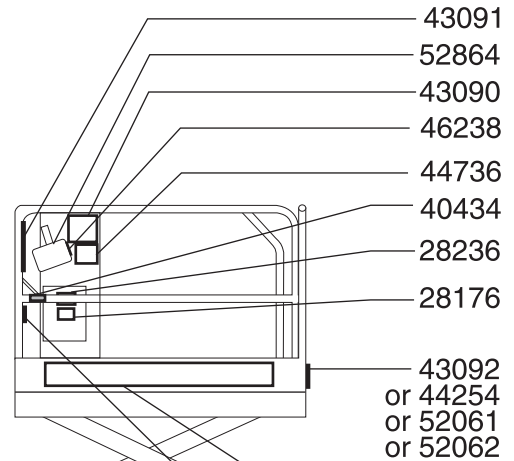

43093 72833 46262 44737 31785

28161 44753 65052 43617 43616 43093

Specifications

Model	GS-1530	
Height, working maximum	21 ft	6.4 m
Height, platform maximum	15 ft	4.6 m
Height, stowed maximum Rails up - CE	80 ¹ / ₄ in	2.04 m
Height, stowed maximum Rails up - ANSI	75 ⁷ / ₈ in	1.93 m
Height, stowed maximum Rails lowered	74 in	1.88 m
Height, stowed maximum Rails off	36 ¹ / ₂ in	93 cm
Height, guard rails	40 in	1.02 m
Width	30 in	76.2 cm
Length, stowed	72 in	1.83 m
Length, platform extended	101 ¹ / ₂ in	2.58. m
Maximum load capacity	600 lbs	272 kg
Wheelbase	52 in	1.32 m
Turning radius (outside)	61 in	1.55 m
Turning radius (inside)	0 in	0 cm
Ground clearance	2 ⁵ / ₈ in	6.7 cm
Ground clearance Pothole guards deployed	7 ⁷ / ₈ in	2.2 cm
Weight (Machine weights vary with option configurations)	See Serial Plate	
Gradeability	30%	
Airborne noise emissions Maximum sound level at normal operating workstations (A-weighted)	>70 dB	

Power source	4 Batteries, 6V 245AH	
Controls	Proportional	
Platform dimensions, (length x width)	62 ¹ / ₄ x 25 ¹ / ₂ in	1.6 m x 65 cm
Platform extension length	39 ¹ / ₄ in	1 m
AC outlet in platform	standard	
Maximum hydraulic pressure (functions)	3000 psi	207 bar
Tires size	12 x 4.5 x 8 in	

Drive speeds

Stowed, maximum	2.5 mph	4.0 km/h
Platform raised, maximum	0.5 mph	0.7 km/h
		40 ft/55 sec
		12.5 m/55 sec

Floor Loading Information

GVW + Rated Load	3258 lbs	1478 kg
Axle load, maximum	2400 lbs	1088 kg
Wheel load, maximum	1200 lbs	544 kg
Localized pressure per tire	133 psi	9.38 kg/cm ² 919 kPa
Occupied pressure	211 psf	10.1 kPa

Note: Floor loading information is approximate and does not incorporate different option configurations. It should be used only with adequate safety factors.

SPECIFICATIONS

Model	GS-1930	
Height, working maximum	25.1 ft	7.7 m
Height, platform maximum	19.1 ft	5.8 m
Height, stowed maximum Rails up - CE	82 ¹ / ₂ in	2.1 m
Height, stowed maximum Rails up - ANSI	78 ¹ / ₄ in	1.99 m
Height, stowed maximum Rails lowered	76 ⁵ / ₁₆ in	1.94 m
Height, stowed maximum Rails off	38 ¹ / ₂ in	98 cm
Height, guard rails	40 in	1.02 m
Width	30 in	76.2 cm
Length, stowed	72 in	1.83 m
Length, platform extended	101 ¹ / ₂ in	2.58 m
Maximum load capacity	500 lbs	227 kg
Wheelbase	52 in	1.32 m
Turning radius (outside)	61 in	1.55 m
Turning radius (inside)	0 in	0 cm
Ground clearance	2 ⁵ / ₈ in	6.7 cm
Ground clearance Pothole guards deployed	7/8 in	2.2 cm
Weight (Machine weights vary with option configurations)	See Serial Plate	
Gradeability	30%	
Airborne noise emissions Maximum sound level at normal operating workstations (A-weighted)	>70 dB	

Power source	4 Batteries, 6V 245AH	
Controls	Proportional	
Platform dimensions, (length x width)	62 ¹ / ₄ x 25 ¹ / ₂ in 1.6 m x 65 cm	
Platform extension length	39 ¹ / ₄ in	1 m
AC outlet in platform	standard	
Maximum hydraulic pressure (functions)	3500 psi	241 bar
Tires size	12 x 4.5 x 8 in	

Drive speeds

Stowed, maximum	2.5 mph	4.0 km/h
Platform raised, maximum	0.5 mph	0.7 km/h
	40 ft/55 sec 12.5 m/55 sec	

Floor Loading Information

GVW + Rated Load	3456 lbs	1568 kg
Axle load, maximum	2460 lbs	1115 kg
Wheel load, maximum	1230 lbs	558 kg
Localized pressure per tire	137 psi	9.62 kg/cm ² 942 kPa
Occupied pressure	231 psf	11.05 kPa

Note: Floor loading information is approximate and does not incorporate different option configurations. It should be used only with adequate safety factors.

Continuous improvement of our products is a Genie policy.
Product specifications are subject to change without notice or obligation.

Genie Scandinavia
Phone +46 31 3409612
Fax +46 31 3409613

Genie France
Phone +33 (0)2 37 26 09 99
Fax +33 (0)2 37 26 09 98

Genie Iberica
Phone +34 93 579 5042
Fax +34 93 579 5059

Genie Germany
Phone +49 (0)4202 88520
Fax +49 (0)4202 8852-20

Genie U.K.
Phone +44 (0)1476 584333
Fax +44 (0)1476 584334

Genie Mexico City
Phone +52 55 5666 5242
Fax +52 55 5666 3241

Genie North America
Phone 425.881.1800
Toll Free USA and Canada
800.536.1800
Fax 425.883.3475

Genie Australia Pty Ltd.
Phone +61 7 3375 1660
Fax +61 7 3375 1002

Genie China
Phone +86 21 53852570
Fax +86 21 53852569

Genie Malaysia
Phone +65 98 480 775
Fax +65 67 533 544

Genie Japan
Phone +81 3 3453 6082
Fax +81 3 3453 6083

Genie Korea
Phone +82 25 587 267
Fax +82 25 583 910

Genie Brasil
Phone +55 11 41 665 755
Fax +55 11 41 665 754

Genie Holland
Phone +31 183 581 102
Fax +31 183 581 566

Distributed By: